

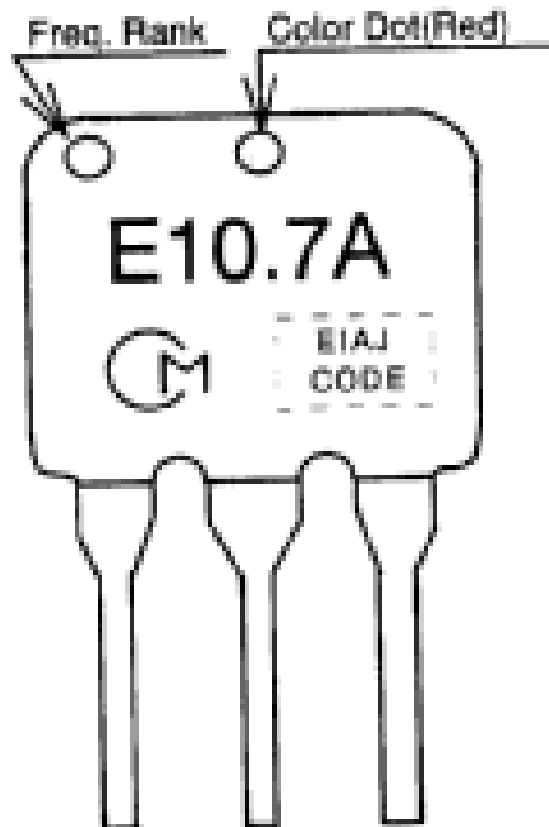

10.7 MHz Leaded Filter Part Marking Manual



There are five components in determining the part numbers from Murata's 10.7 MHz filters part markings:

1. The part marking itself,
2. the frequency rank color dot. The location of this dot is important not color (Color is used to determine frequency rank, see table 1.)
3. The Murata trademark
4. The EIA J single letter date code
5. An additional color dot may appear on the part

Table 1 indicates the possible center frequency rank for the 10.7 MHz filters. While all ranks are possible, all ranks have not been designed for each 10.7 MHz part number. Please consult with your local Murata sales rep for rank and availability for specific 10.7 MHz part numbers.

Color Code	30 kHz Step Tolerance Code Equal to "No Code"	Code
Black	10.64 MHz±30kHz	D
Blue	10.67 MHz±30kHz	B
Red*	10.70 MHz±30kHz	A
Orange	10.73 MHz±30kHz	C
White	10.76 MHz±30kHz	E

Table: 1

*indicates standard frequency rank.

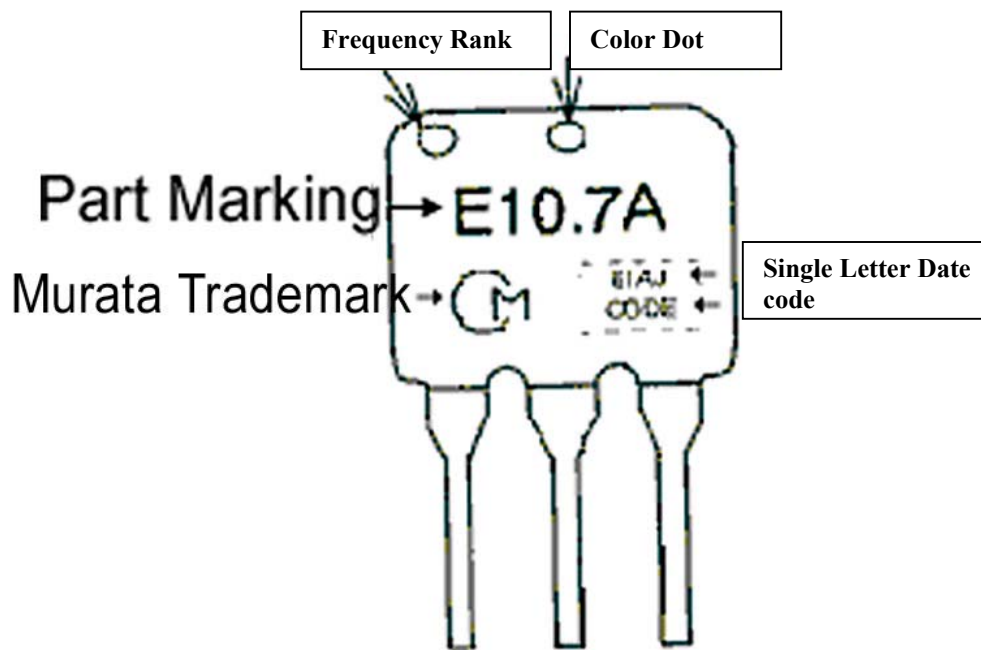

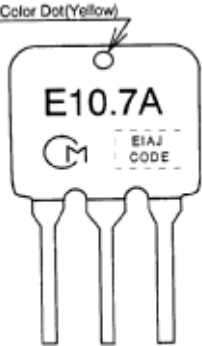
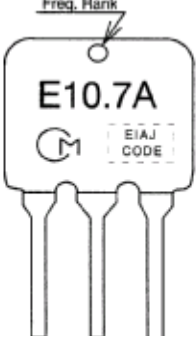
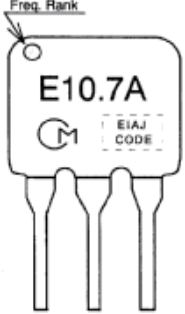
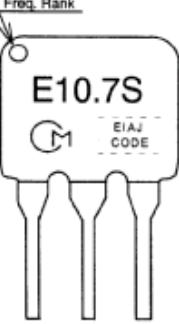
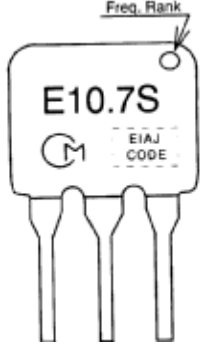
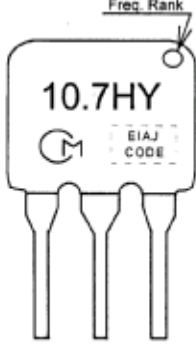
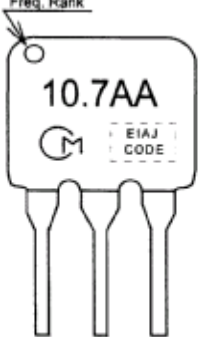
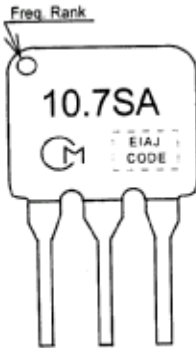
	<p>Previous Part Number SFE10.7MA19 Global Part Number SFELA10M7DF00-B0</p>		<p>Previous Part Number SFE10.7MA20-A Global Part Number SFELA10M7EA00-B0</p>
	<p>Previous Part Number SFE10.7MA5-A Global Part Number SFELA10M7FA00-B0</p>		<p>Previous Part Number SFE10.7MS2-A Global Part Number SFELA10M7GA00-B0</p>
	<p>Previous Part Number SFE10.7MS3-A Global Part Number SFELA10M7HA00-B0</p>		<p>Previous Part Number SFE10.7MHY-A Global Part Number SFELA10M7KAH0-B0</p>
	<p>Previous Part Number SFE10.7MA5A10-A Global Part Number SFELA10M7FAA-B0</p>		<p>Previous Part Number SFE10.7MS2A10-A Global Part Number SFELA10M7GAA0-B0</p>

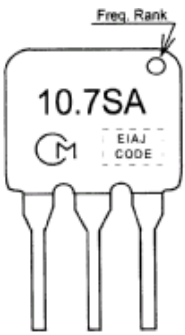
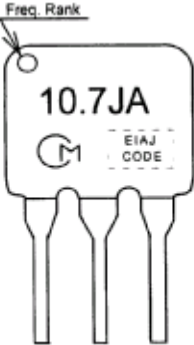
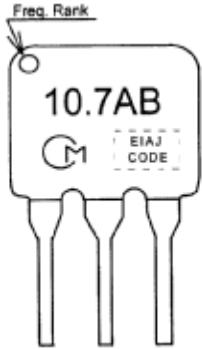
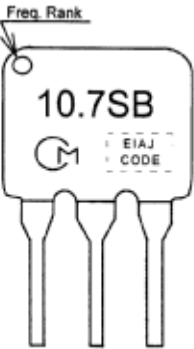
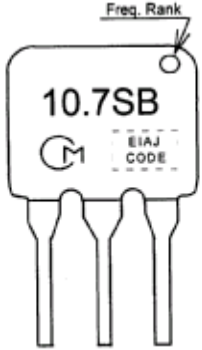
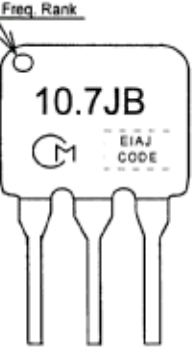
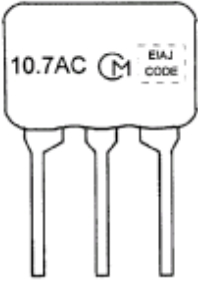
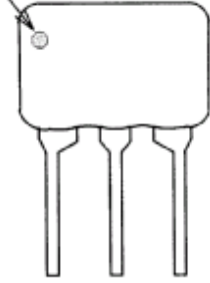
	<p>Previous Part Number SFE10.7MS3A10-A Global Part Number SFELA10M7HAA0-B0</p>		<p>Previous Part Number SFE10.7MJA10-A Global Part Number SFELA10M7JAA0-B0</p>
	<p>Previous Part Number SFE10.7MA5B10-A Global Part Number SFELA10M7FAB0-B0</p>		<p>Previous Part Number SFE10.7MS2B10-A Global Part Number SFELA10M7GAB0-B0</p>
	<p>Previous Part Number SFE10.7MS3B10-A Global Part Number SFELA10M7HAB0-B0</p>		<p>Previous Part Number SFE10.7MJB10-A</p>
<p>Front</p>  <p>Back</p> 		<p>Previous Part Number SFE10.7MA5C10-A Global Part Number SFELB10M7FA00-B0</p>	

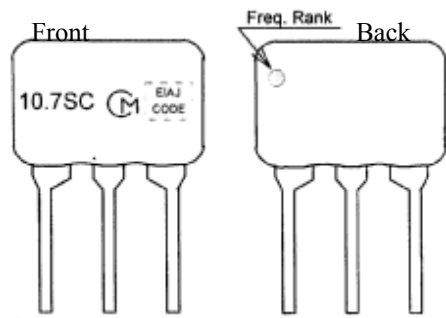

Previous Part Number
SFE10.7MS2C10-A
Global Part Number
SFELB10M7GA00-B0

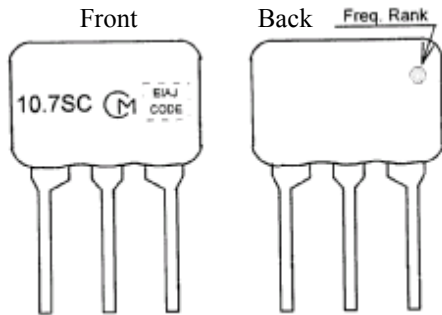

Previous Part Number
SFE10.7MS3C10-A
Global Part Number
SFELB10M7HA00-B0

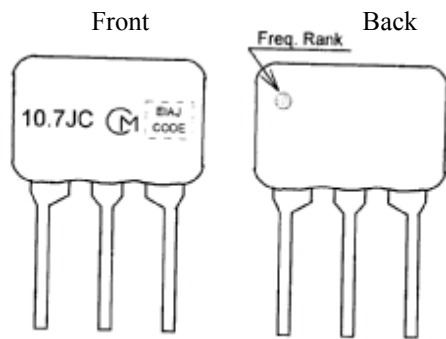

Previous Part Number
SFE10.7MJC10-A
Global Part Number
SFELA10M7JAA0-B0

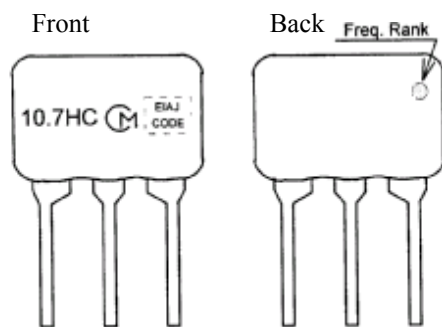

Previous Part Number
SFE10.7MHC10-A
Global Part Number
SFELB10M7KA00-B0

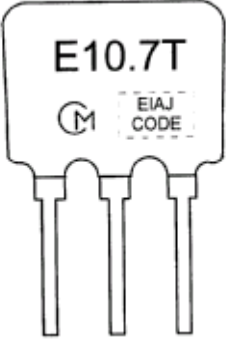
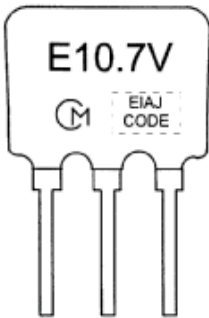
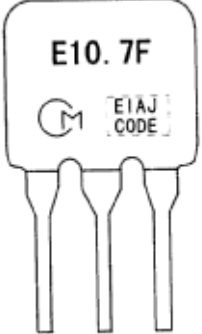
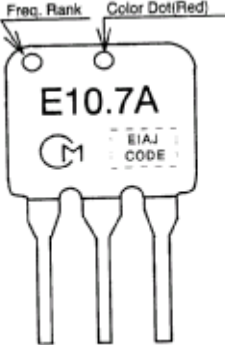
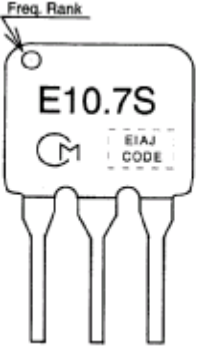
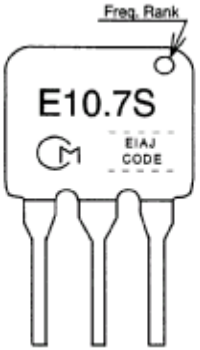
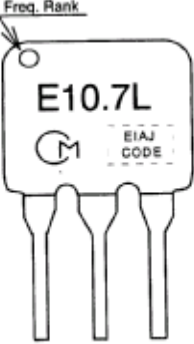
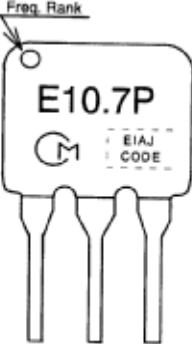
 <p>E10.7T M EIAJ CODE</p>	<p>Previous Part Number SFE10.7MTE Global Part Number SFVLA10M7LF00-B0</p>	 <p>E10.7V M EIAJ CODE</p>	<p>Previous Part Number SFE10.7MVE Global Part Number SFVLA10M7MF00-B0</p>
 <p>E10.7F M EIAJ CODE</p>	<p>Previous Part Number SFE10.7MFP Global Part Number SFKLA10M7NL00-B0</p>	 <p>Freq. Rank Color Dot (Red) E10.7A M EIAJ CODE</p>	<p>Previous Part Number SFE10.7MA8-A Global Part Number SFELA10M7FA0G-B0</p>
 <p>Freq. Rank E10.7S M EIAJ CODE</p>	<p>Previous Part Number SFE10.7MS2G-A Global Part Number SFELA10M7GA0G-B0</p>	 <p>Freq. Rank E10.7S M EIAJ CODE</p>	<p>Previous Part Number SFE10.7MS3G-A Global Part Number SFELA10M7HA0G-B0</p>
 <p>Freq. Rank E10.7L M EIAJ CODE</p>	<p>Previous Part Number SFE10.7ML-A Global Part Number SFELA10M7FALL-B0</p>	 <p>Freq. Rank E10.7P M EIAJ CODE</p>	<p>Previous Part Number SFE10.7MP3-A Global Part Number SFELA10M7GALP03-B0</p>

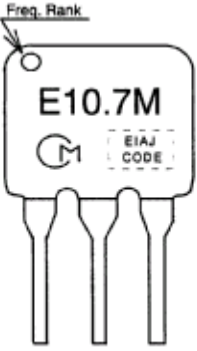
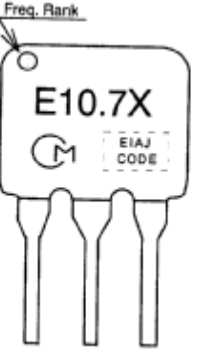
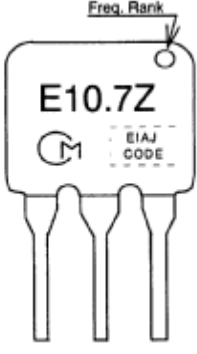
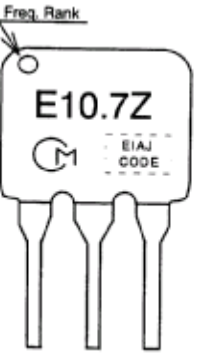
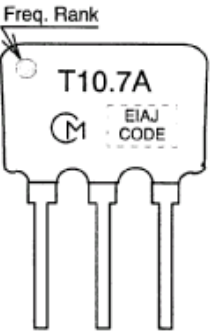
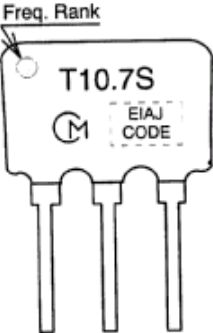
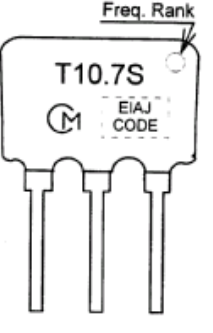
	<p>Previous Part Number SFE10.7MM-A Global Part Number SFELA10M7GALM-B0</p>		<p>Previous Part Number SFE10.7MX2-A Global Part Number SFELA10M7GAXA-B0</p>
	<p>Previous Part Number SFE10.7MZ1-A Global Part Number SFELA10M7HAXD-B0</p>		<p>Previous Part Number SFE10.7MZ2-A Global Part Number SFELA10M7JAXE-B0</p>
	<p>Previous Part Number SFT10.7MA5-A Global Part Number SFTLA10M7FA00-B0</p>		<p>Previous Part Number SFT10.7MS2-A Global Part Number SFTLA10M7GA00-B0</p>
	<p>Previous Part Number SFT10.7MS3-A Global Part Number SFTLA10M7HA00-B0</p>		